



# MirroSky Series SPi53 Smart Telescope



[Setup Video](#)



[Latest Manual](#)



[Customer Service](#)



[Visit Our Website](#)



<b>INTRODUCTION</b> .....	<b>2</b>
<b>WARNINGS</b> .....	<b>2</b>
<b>PARTS LIST</b> .....	<b>3</b>
<b>OPTIONAL ACCESSORIES</b> .....	<b>3</b>
<b>MAJOR COMPONENTS</b> .....	<b>3</b>
<b>CONFIGURATION GUIDE</b> .....	<b>5</b>
<b>SETUP GUIDE</b> .....	<b>6</b>
<b>CONFIGURATION 1</b> .....	<b>6</b>
<b>CONFIGURATION 2</b> .....	<b>7</b>
<b>CONFIGURATION 3</b> .....	<b>8</b>
<b>GETTING READY</b> .....	<b>10</b>
<b>FOCUSING THE OTA</b> .....	<b>11</b>
<b>HOW TO USE IN AZ MODE</b> .....	<b>11</b>
<b>TERRESTIAL VIEWING</b> .....	<b>11</b>
<b>CELESTIAL VIEWING / IMAGING</b> .....	<b>12</b>
<b>SPECIFICATIONS</b> .....	<b>14</b>
<b>WARRANTY</b> .....	<b>15</b>
<b>RETURN POLICY</b> .....	<b>15</b>
<b>CUSTOMER SERVICE</b> .....	<b>15</b>



The next generation of smart telescopes have arrived with a new modular design that allows both visual and photographic use of your smart telescope! The MirroSky Sky Pilot 53, also known as the SPI53, is a first of its kind smart telescope that allows you the option to look directly through the telescope with your eyes and see the ancient light from our galactic neighbors firsthand. No other smart telescope on the market can do this!

The SPI53 comes equipped with the MirroSky Intelligent Camera System which brings the smarts to this smart telescope. Equipped with a Sony IMX662 CMOS imaging sensor, premium 53mm optic with extra-low dispersion glass (ED), and custom MirroSky app with 100,000+ object database, this compact system can locate, track, and image night sky targets automatically. You can even do this in the comfort of your own home while this tiny telescope is outside doing all the hard work!

Designed in the USA, the SPI53 can accept an additional optical tube assembly (OTA) along with the included 53mm ED optic so you can view visually and photograph at the same time! For best results, we recommend pairing a 70mm or smaller optic with a focal ratio of f/6 or less when using two optics at the same time. A larger tripod is also recommended for added stability when using two OTAs.





We at Spectrum Optics are certain the SPI53 will bring years of night sky enjoyment by removing the complications of locating and imaging the night sky and letting you spend more time viewing its celestial wonders.



If during your explorations you have questions regarding the use of our products, please feel free to contact our highly trained staff who can assist you quickly.

To get you started with your night sky adventures, we recommend reading through this manual to learn about all the exciting features the SPI53 has to offer. A SPI53 setup video is also available at <https://spectrumoi.com/project/spi53/>

The SPI53 carries a Two-Year Limited Warranty, honored by Spectrum Optical Instruments. For details, please see our warranty at [https://spectrumoi.com/refund\\_returns/](https://spectrumoi.com/refund_returns/).

## WARNINGS

 <b>WARNING</b>		
 	<ul style="list-style-type: none"><li>• <b>INGESTION HAZARD:</b> This product contains small parts.</li><li>• <b>INGESTION HAZARD:</b> This product contains a button cell or coin battery.</li><li>• <b>DEATH</b> or serious injury can occur if ingested.</li><li>• A swallowed button cell or coin battery can cause <b>INTERNAL CHEMICAL BURNS</b> in as little as <b>2 HOURS</b>.</li><li>• Ensure <b>PROPER SUPERVISION</b> and keep small parts <b>OUT OF REACH OF CHILDREN</b>.</li><li>• <b>SEEK IMMEDIATE MEDICAL ATTENTION</b> if a small part or a coin battery is suspected to be swallowed or inserted inside any part of the body.</li></ul>	 

 <b>SOLAR WARNING</b>	
<ul style="list-style-type: none"><li>• Solar observations require <b>SPECIAL PRECAUTIONS</b> to ensure the safety of both your eyes and your equipment.</li><li>• The Sun emits intense and <b>POTENTIAL HARMFUL RADIATION</b>, including ultraviolet and infrared light.</li><li>• Observing the Sun without proper solar rated gear can lead to <b>IRREVERSIBLE DAMAGE</b> to your eyes and equipment.</li></ul>	



SPI AZ Mount	x1	MS Intelligent Camera	x1
53mm ED Optical Tube	x1	Tabletop Tripod w/ Pouch	x1
AC Adapter	x1	Viewfinder Dovetail	x1
USB-C Cable	x2	M5x0.8 Hardware Screws	x2
USB-C to 5.5mm Adapter	x1	Hex Key	x1
Instruction Manual	x1	Carry Case	x1

## OPTIONAL ACCESSORIES

Carbon Tripod & Backpack	x1	Counterweight & Shaft	x1
EQ Wedge	x1	64mm ED Optical Tube	x1

## MAJOR COMPONENTS



Fig. 1.1

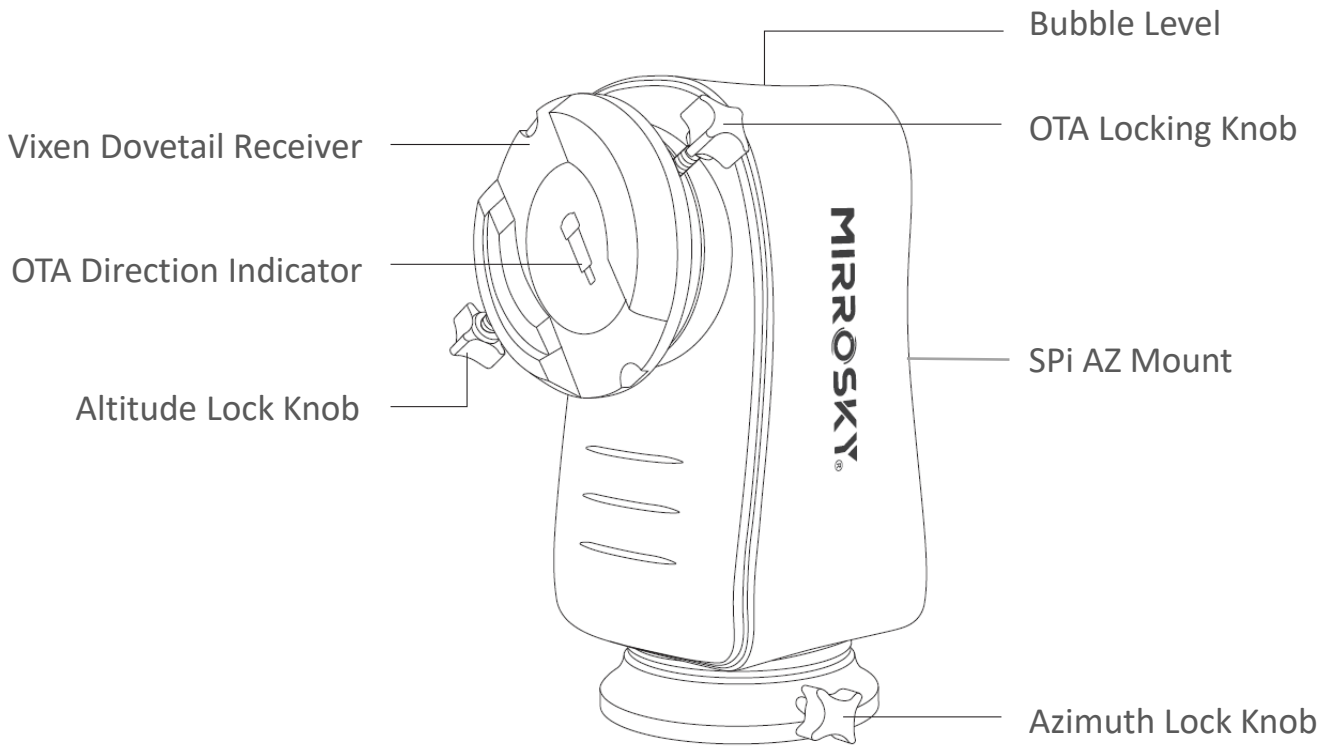

Fig. 1.2

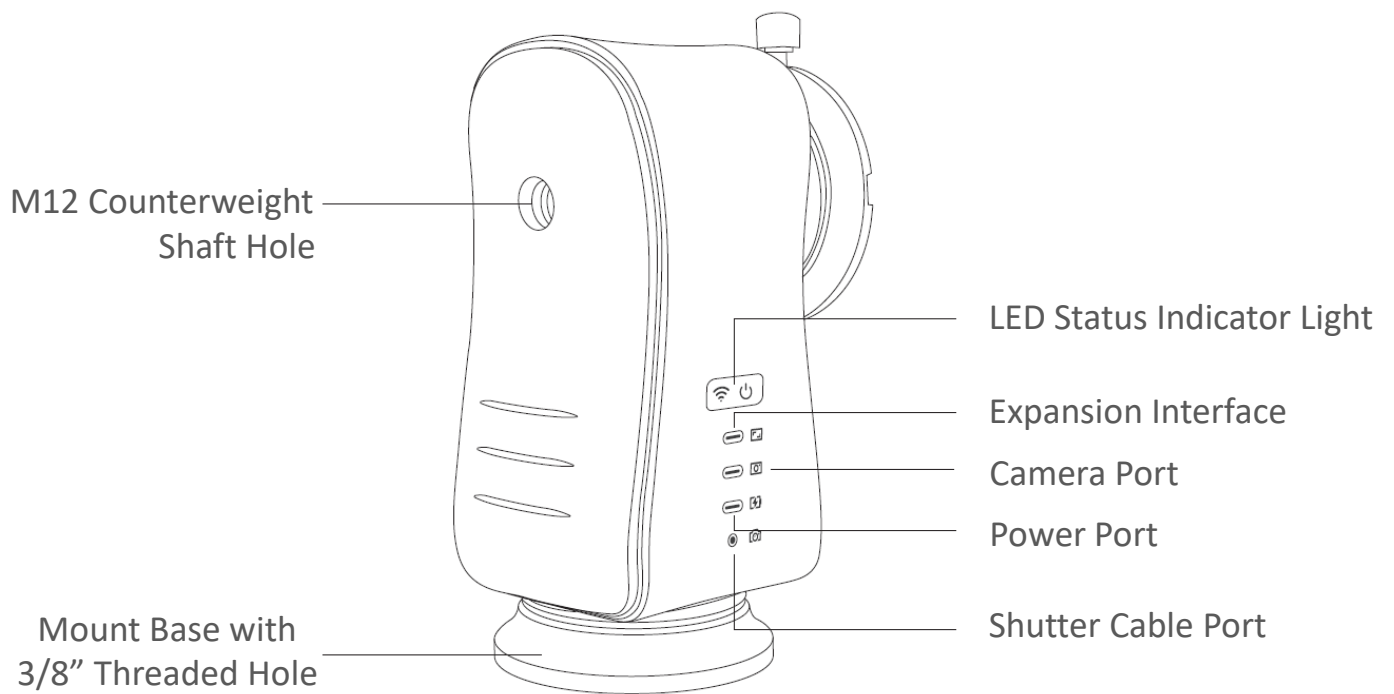

Fig. 1.3



The SPI53 can be operated in three different configurations depending on how you want to use the instrument. All three configurations are set up in alt-azimuth (AZ) mode which means one axis moves up/down in the altitude direction, and other axis moves left/right in the azimuth direction. The AZ mode is the default mode and simplest to use.

More advanced modes such as equatorial (EQ) mode require tilting the azimuth axis toward the celestial pole and requires the optional EQ Wedge. The EQ mode allows for the ability to take longer exposures without field rotation of the imaging field occurring. We highly recommend starting your adventures with the AZ mode before attempting to use the EQ wedge.

\* Note: Any user-supplied OTA should have a 70mm objective lens or smaller and focal ratio of f/6 or less. The maximum payload capacity for the MirroSky system is 6.8 lbs (3kg).



Fig. 2.1

**Configuration 1 (Default Imaging Config):**

- **Difficulty Level:** Easy
- **Requires:** 53mm ED OTA, Intelligent Camera, SPi Mount, Tabletop tripod



Fig. 2.2

**Configuration 2 (Upgraded Imaging Config):**

- **Difficulty Level:** Easy
- **Requires:** User-supplied OTA\* with Vixen dovetail, Intelligent Camera, SPi Mount, Upgraded Optional Tripod is required



Fig. 2.3

**Configuration 3 (Dual Telescope Config):**

- **Difficulty Level:** Intermediate
- **Requires:** User-supplied OTA\* with Vixen dovetail rail and viewfinder mounting, 53mm ED OTA, Intelligent Camera, SPi Mount, Upgraded Optional Tripod is required.
- Visual telescope requires a 90-degree diagonal and eyepieces.



## Configuration 1



Fig. 3.1



Fig. 3.2



Fig. 3.3



Fig. 3.4



Fig. 3.5



Fig. 3.6



Fig. 3.7



Fig. 3.8

1. Unpack the tripod and locate the large collar at the top. Turn it counterclockwise to fully unlock the tripod legs. Do not use the tripod when locked and with the narrow leg position as it may tip over.
2. Attach the mount to the tripod by threading them together See Fig. 3.1.
3. Fully spread the tripod legs and place the telescope on a stable, flat surface.
4. The 53mm ED OTA should come with the Vixen dovetail pre-installed (see Fig. 3.3). If not, remove the existing bracket and install it using the included M5 screws and hex key (see page 8, Fig. 5.3 for reference).
5. Align the OTA with the arrows on the mount's dovetail receiver (see Fig. 3.4). Insert the Vixen dovetail and tighten the OTA lock knob to a firm feel.
6. Remove dust caps from the camera nosepiece and both ends of the OTA.
7. Insert the camera into the OTA's focuser with the "TOP" label facing up. Tighten the two thumbscrews to secure it. Note: A slight imbalance of the OTA on the altitude axis will cause no issue with the SPI's performance.
8. Connect the camera to the mount using the provided USB-C cable. Plug one end into the camera's "Power" port and the other into the mounts port labeled  (see Fig. 3.6 & 3.7).
9. When ready to use the telescope on the night sky, point the OTA slightly downward from horizontal, then tighten the mounts altitude and azimuth knobs. This ensures the driving motors engage properly.



## Configuration 2



Fig. 4.1



Fig. 4.2



Fig. 4.3



Fig. 4.4



Fig. 4.5



Fig. 4.6



Fig. 4.7

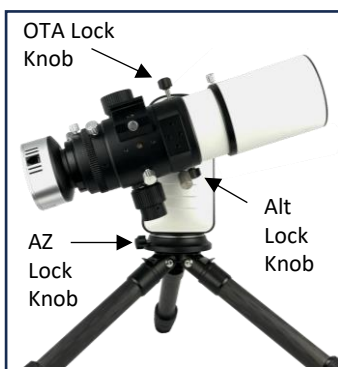



Fig. 4.8

In this configuration a user-supplied OTA is used along with an upgraded tripod. We recommend our optional Carbon Fiber tripod to provide more stability. However, a robust photo tripod can also be used if it has a 3/8" male mounting screw.

Note: The SPi mount is designed for use with optical tubes of 70mm apertures and smaller, a focal ratio of f/6 or less, and requires a Vixen dovetail rail. The SPi mount has a maximum payload capacity of 6.8 lbs (3 kg).

1. Attach the mount to the upgraded tripod by threading them together until firm (see Fig. 4.1).
2. Fully spread and extend the tripod legs and place the telescope on a stable, flat surface. See Fig. 4.2.
3. Align the OTA with the arrows on the mount's dovetail receiver (see Fig 4.3). Insert the Vixen dovetail and tighten the OTA lock knob to a firm feel. The setup will be similar to Fig. 4.4.
4. Remove dust caps from the camera nosepiece and both ends of the OTA.
5. Insert the camera into the OTA's focuser with the "TOP" label facing up. See Fig. 4.5. Tighten the focuser thumbscrews to secure it.
6. Connect the camera to the mount using the provided USB-C cable. Plug one end into the camera's "Power" port and the other into the mounts port labeled  (see Figs. 4.6 & 4.7).
7. If needed, balance the OTA to reduce motor strain:
  - Hold the OTA and loosen the altitude lock knob.
  - Slightly loosen the OTA lock knob.
  - Slide the OTA forward or backward until it feels balanced.
  - Retighten the OTA and altitude knobs.
8. When ready to use the telescope on the night sky, point the OTA slightly downward from horizontal, then tighten the mounts altitude and azimuth knobs. This ensures the driving motors engage properly.



## Configuration 3



Fig. 5.1



Fig. 5.2

In this configuration a user-supplied OTA and the included 53mm OTA will be assembled and mounted on an upgraded optional tripod as shown in Fig 5.1 & 5.2.

Note: Any user-supplied OTA should have 70mm objective lens or smaller and focal ratio of f/6 or less. The maximum payload capacity for the MirroSky system is 6.8 lbs (3kg).

The flexibility of this configuration allows one telescope to be used for imaging, while the other is used for visual observation. However, if desired, cameras can be attached to both telescopes for dual imaging configuration, although a way to view the second camera is needed.

To get started, follow steps 1-4 in Configuration 2 to attach the tripod and user-supplied OTA to the SPI mount. After, return to this section to continue the setup process.

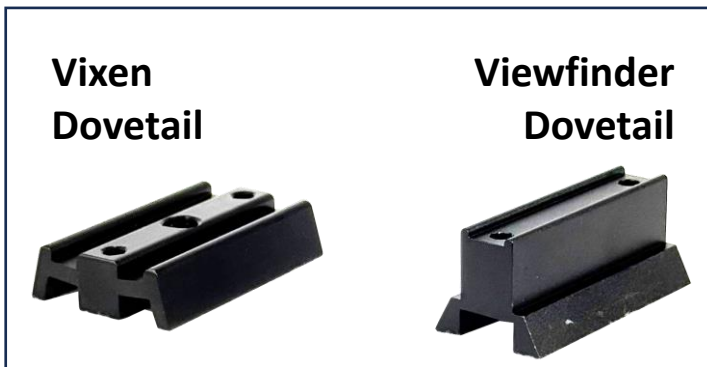

Fig. 5.3

1. Attaching the 53mm OTA to the user-supplied OTA requires replacing the Vixen dovetail with the included Viewfinder dovetail. The 53mm OTA will attach to the viewfinder mounting location on the user-supplied OTA. Fig 5.3 shows both dovetail styles.



Fig. 5.4



Fig. 5.5

2. Remove the Vixen dovetail from the 53mm OTA by removing the 2 mounting screws from the bottom of the dovetail as shown in Fig 5.4.

3. Attach the included Viewfinder dovetail bracket to the 53mm OTA using the two M5x12mm screws provided with the bracket. See Fig 5.5. Note they are slightly shorter screws to prevent interference with the 53mm OTA. Tighten both to a firm feel.

4. Install the 53mm OTA onto the user supplied OTA and tighten the mounting screws to a firm feel.

5. Remove the dust caps from the camera nosepiece and OTA and set them aside.



Fig. 5.6

Note: The Intelligent Camera can be installed onto either optical tube for imaging or guiding on a night sky object. If mounting onto the user-supplied telescope, you may need to use an additional extension tube to achieve focus. The telescope being used for visual observation requires a user-supplied 90-degree diagonal and eyepiece.



## Configuration 3 Continued



Fig. 5.7



Fig. 5.8



Fig. 5.9

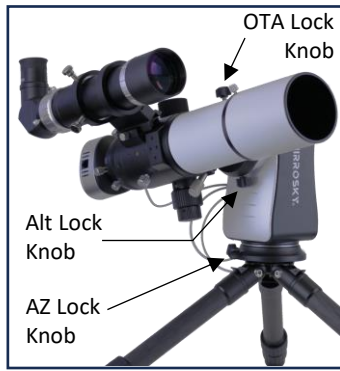

Fig. 5.10

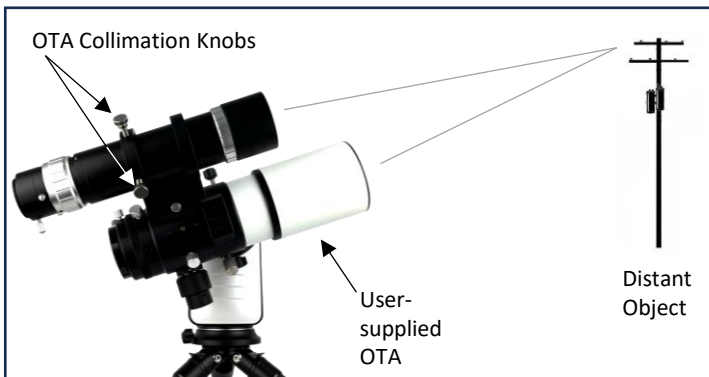



Fig. 5.11

6. Insert the camera into either OTA's focuser with the "TOP" label facing up. See Fig. 5.7. Tighten the focuser thumbscrews to secure it.
7. Connect the camera to the mount using the provided USB-C cable. Plug one end into the camera's "Power" port and the other into the mounts port labeled  (see Figs. 5.8 & 5.9).
8. If needed, balance the OTA to reduce motor strain:
  - Hold the OTA and loosen the altitude lock knob.
  - Slightly loosen the OTA lock knob.
  - Slide the OTA forward or backward until it feels balanced.
  - Retighten the OTA and altitude knobs.

### ALIGNING THE OTAS

9. For best results, both OTAs need to be pointing at the same object. This requires aligning the 53mm OTA to the user-supplied OTA using the Collimation Knobs.
10. During the daytime, point the user-supplied OTA at a distant target such as a streetlamp or utility pole. Focus the user-supplied OTA and center the object in the field of view. See Fig. 5.11.

**NOTE: DO NOT POINT THE TELESCOPE AT OR NEAR THE SUN WITHOUT PROPER SOLAR FILTERS INSTALLED OR PERMANENT DAMAGE CAN OCCUR TO YOUR EYES AND EQUIPMENT.**

11. Now adjust the 53mm OTA by only using the OTA Collimation Knobs so it is looking at the same object as the user-supplied OTA. Now when an object is viewed in one telescope, it will also appear in the other. If needed, more precise alignment can be done on the night sky.

12. When ready to use the telescope on the night sky, point the OTA slightly downward from horizontal, then tighten the mounts altitude and azimuth knobs. This ensures the driving motors engage properly.

 **SOLAR WARNING**

<ul style="list-style-type: none"> <li>• Solar observations require <b>SPECIAL PRECAUTIONS</b> to ensure the safety of both your eyes and your equipment.</li> <li>• The Sun emits intense and <b>POTENTIAL HARMFUL RADIATION</b>, including ultraviolet and infrared light.</li> <li>• Observing the Sun without proper solar rated gear can lead to <b>IRREVERSIBLE DAMAGE</b> to your eyes and equipment.</li> </ul>	
---	---



Fig. 6.1



Fig. 6.2



Fig. 6.3



Fig. 6.4



Fig. 6.5

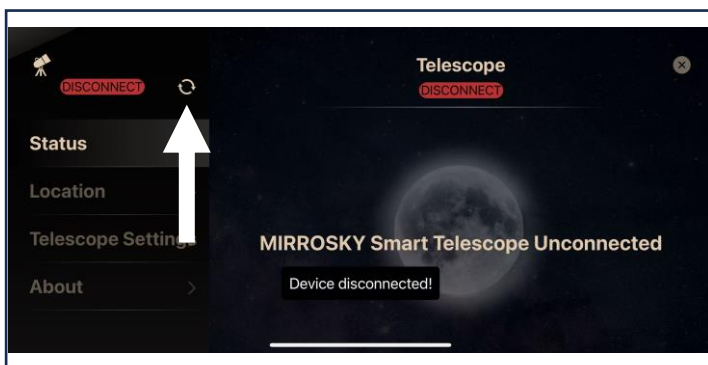





Fig. 6.6

1. Scan the QR Code (Fig. 6.1) to download the MirroSky APP (Fig. 6.2) or search “MirroSky” and download it from the major APP store.
2. Start the MirroSky APP and when prompted, allow the APP to gain access to your photo album and your location. Photo album access is needed to store the images taken from MirroSky. Location data is needed as the SPI53 uses the phones GPS location, date, and time to align the telescope.
3. Plug the included AC adapter into the wall outlet, and plug the other end into the power port  located on the mount. If preferred, you may use any power bank that supplies 12V power. See Fig. 6.3
4. After being plugged in, the SPI53 performs an auto-home action in the horizontal and vertical directions. When the auto calibrate procedure is complete, the OTA should be parallel to the horizon.

Note: During the auto-home action, the altitude axis moves in a counterclockwise direction to find the level position. As such, it is recommended to start with the OTA pointed slightly below horizontal or the altitude axis will take longer to find level.

5. Open the Wi-Fi setting on your phone or tablet and connect to the Wi-Fi named “MOS\_XXXXXXX” by using the password “12345678.” You may change the Wi-Fi name and password through the APP. See Fig. 6.4
6. Once connected, you should see a green icon located in the upper left corner of the APP home page which states “CONNECTED” See Fig. 6.5
7. In case your telescope is disconnected from your APP and showing a “DISCONNECTED” in red, press the telescope icon  and press the refresh icon  next to the telescope icon, and the telescope will reconnect to your APP. See Fig. 6.6

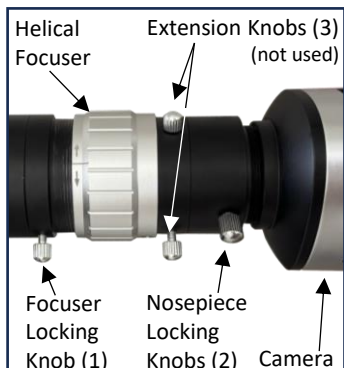

Fig. 7.1



Fig. 7.2

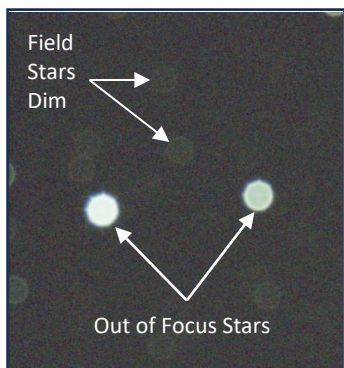

Fig. 7.3

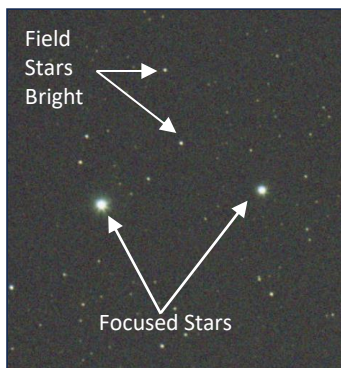

Fig. 7.4

The included 53mm ED OTA features a helical focuser with approximately 16 mm of travel. To focus, loosen the focuser locking knob and rotate the silver focuser ring until the image appears sharp (see Figures 7.1 and 7.2).

For initial use under the night sky, the telescope may not be set to infinity focus. To quickly approximate focus, use the etched reference marks on the focuser. First, loosen the Focuser Locking Knob located in front of the Helical Focuser. Then, rotate the focuser until the etched line and edge of focuser ring (Fig. 7.2) are aligned and have no gap between them. This will get you close to infinity focus.

Next, fine-tune focus by adjusting the focuser while observing a bright star. Out-of-focus stars will appear large and blurry (Fig. 7.3); continue adjusting until the brightest star appears as small and sharp as possible (Fig. 7.4). As focus improves, fainter stars will also become visible. Once focus is achieved, re-tighten the Focuser Locking Knob until secure.

## Terrestrial Viewing



To start viewing terrestrial objects, tap the “EXPLORATION” button located on the bottom left of the main screen.

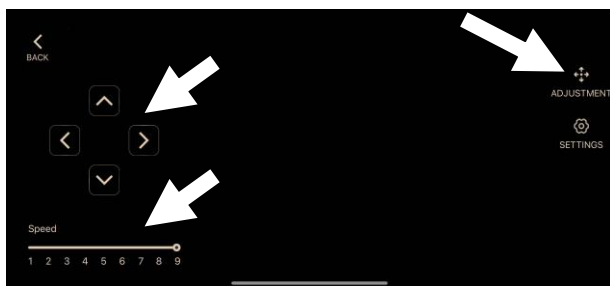

In the “EXPLORATION” page, clicking the “ADJUSTMENT” button enables you to adjust the slewing direction and speed of the telescope. Use the arrows on the left side of the screen to move the telescope in each direction as desired. You can also change the telescope speed by adjusting the speed bar as needed (“1” is the slowest speed and “9” is the fastest).

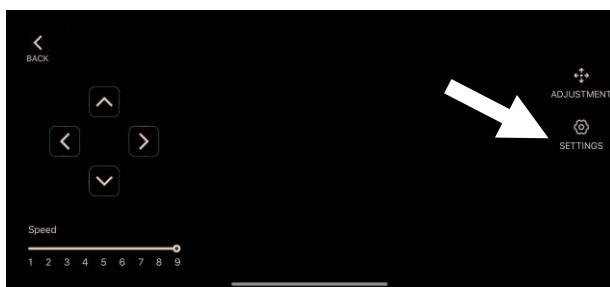

In the “EXPLORATION” page, click the “SETTINGS” button to adjust various camera settings such as the Resolution, Gain, Exposure Time and Crosshair.



## Terrestrial Viewing Continued

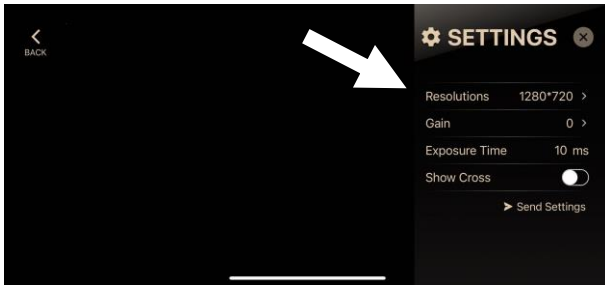

You may change the camera settings for different viewing modes and targets.

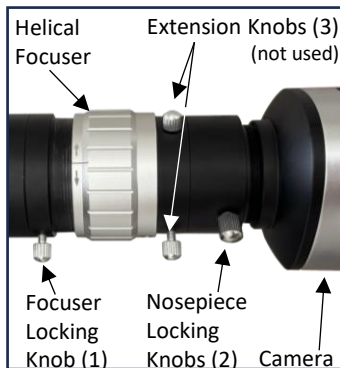

After centering the object you'd like to observe, you may need to adjust the telescope focus. Adjust the telescope focus by rotating the silver focuser ring.

Note: Rotating the focuser counterclockwise (looking from the back of the telescope) brings the focus closer, and rotating the focuser clockwise (looking from the back of the telescope) takes the focus further way. For a more detailed use of the focuser, please see the section titled "Focusing the OTA".

## Celestial Viewing / Imaging

To locate celestial objects in the MirroSky APP, you can search for the object by name or select it directly from the sky map. Once selected, you can have the SPi mount "GoTo" the object and start imaging it.

### Method 1: Name Search



To search for a celestial object, tap the  icon located on the top right corner of the sky map. The object search page will open.

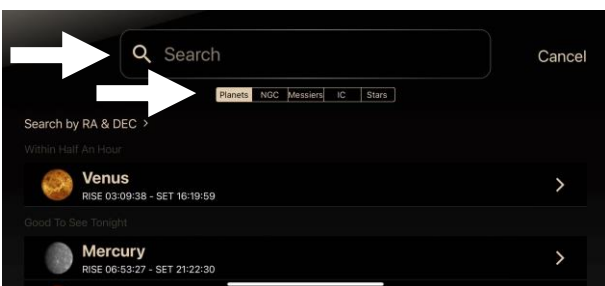

In the search page, enter the Name, NGC, Messier, or IC number of the object you'd like to observe into the search bar.

You may also select the desired object from the object list located under the search bar. Select the object you'd like to observe.



## Celestial Viewing / Imaging Continued

### Method 2: Sky Map



To enable the full sky map function, you will need to enable the Gravity Sensor feature. Tap the “Layers” icon  located on the bottom right corner of the sky map.



Enable the Gravity Sensor to allow the APP to show the location of the celestial objects in real time when you move the phone or tablet across the sky.

You may also enable or disable the sky map appearance of “Constellation,” “Atmosphere,” or “Nebula” to your preference. Click the object you’d like to observe.

If you know exactly which object you would like to observe, it is recommended to use the “Name Search” method. However, if you would just like to explore a specific part of the night sky, it is recommended to use the “Sky Map” method so you can zoom in and out on the map to locate and select your desired object.

After you have selected an object to observe, follow the steps below and the telescope will slew to and start imaging this object.

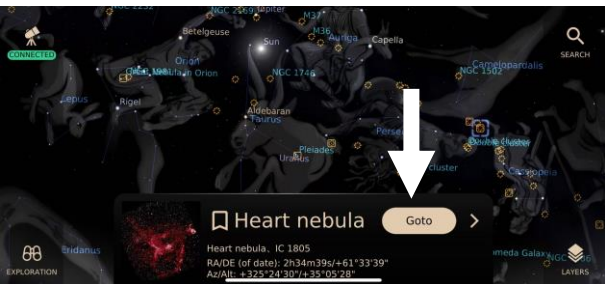

After selecting the object to observe, the coordinates of the object will appear in the bottom of the screen along with a “Goto” icon. Select “Goto” and the telescope will automatically plate solve and center the object in your field of view. This process may take up to 2 minutes.

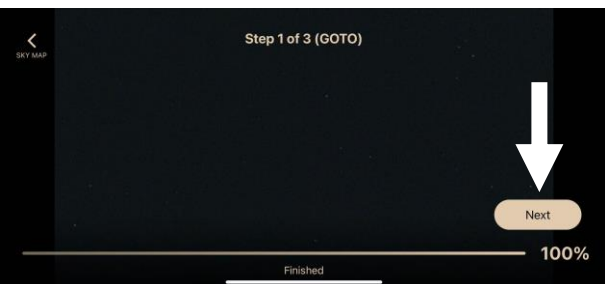

Note the telescope may slew to a different part of the sky to plate solve before slewing to the desired object. If there is an obstacle between the telescope and the object, the plate solve process may need to be redone.

To redo the plate solve process, simply press “Goto” again. When plate solve is complete, press the “Next” icon on the bottom right corner of the screen.

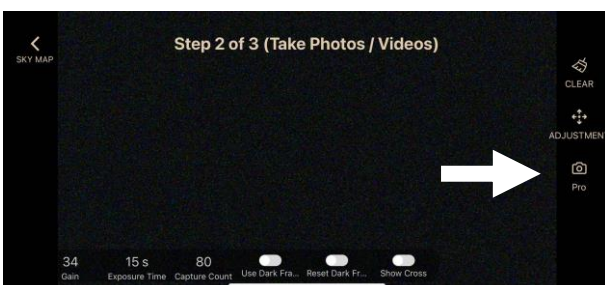



Before taking an image of the object, you may change the camera settings such as the exposure time, number of images taken, gain, and etc. Select the Pro icon to change these settings.

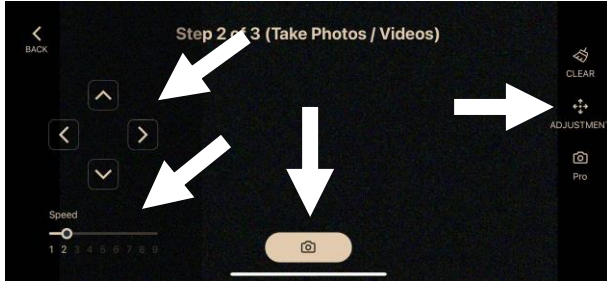

## Celestial Viewing / Imaging Continued



You may also move the telescope around through the APP by pressing the “ADJUSTMENT” icon  with only speed 1. Please note that while moving the telescope around, the telescope continuously tracks the object so you don’t need to worry about losing the target. Once you are done with positioning the object, you may start the imaging process by pressing the camera icon  located at the bottom.

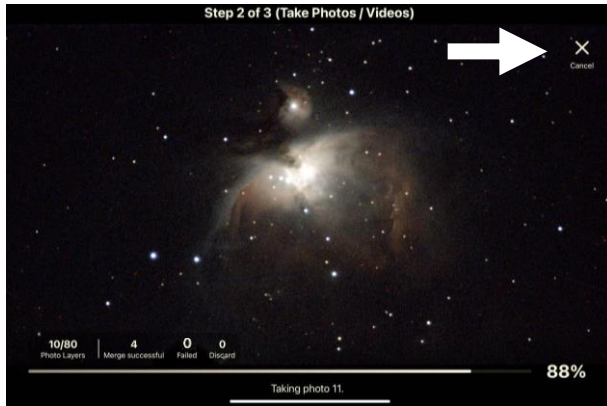

The image begins after pressing the camera icon and the APP starts live-stacking the images. It often takes at least 4 images to start seeing the object detail emerge. As more images are taken and stacked automatically, you may see the object getting brighter and show more detail. You may stop the image taking process anytime by pressing the “Cancel” icon and save the resulting image to your album.

## SPECIFICATIONS

Product Name	MirroSky SPi53 Smart Telescope
Weight	4.4 lbs (Fully Assembled)
Payload Capacity	6.8 lbs (3kg)
Optical Tube Assembly (OTA)	53mm ED Refractor with Helical Focuser
Dovetail	Includes both Vixen and Viewfinder Dovetails
Intelligent Camera	Sony IMX 662 color sensor
Software Application	MirroSky APP (available on iOS and Android)
Astronomical Database	Over 100,000 objects
Motor	Stepper Motor
Altitude Gear	130 tooth worm gear
Azimuth Gear	130 tooth worm gear
Max Slew Speed	7 degrees per second
Tracking Modes	9 speeds including Stellar and Lunar
Compass	Built-in geomagnetic compass
GPS	Location information received through MirroSky App
Counterweight Thread	M12 Threaded Hole
Working Mode	AZ / Sky Tracker Mode
Power Input	DC 12V 2A



Thank you for choosing Spectrum Optics as your trusted source for telescopes, microscopes and other optical products. We stand behind the quality of our products and offer a TWO-YEAR limited warranty from the date of purchase within the US. If a defect is identified on a new product, Spectrum Optical Instruments will repair or replace a product with proof of original purchase. Please note that this warranty only applies to the original purchaser and it is not transferable. Any product that is purchased from anyone or organization other than Spectrum Optical Instruments or authorized dealer is not covered in this warranty.

Additionally, this warranty does NOT cover damage caused by misuse, mishandling, unauthorized repairs, or normal wear and tear. Spectrum Optical Instruments specifically disclaims special, indirect, or consequential damages or lost profit which may result from a breach of this warranty. Any implied warranties which cannot be disclaimed are hereby limited to a term of two years from the date of original retail purchase.

Spectrum Optics shall use reasonable efforts to repair or replace any product covered by this warranty within thirty days of receipt. In an event where repairing or replacement would require more than thirty days, Spectrum Optics shall notify the customer in advanced. Spectrum Optical Instruments reserves the right to replace any obsolete product with a new product of comparable price and performance.

Spectrum Optics reserves the right to change product specifications or to discontinue products without notice. This warranty gives specific rights. You may have other rights which vary from state to state. For warranty inquires, please contact: [customer@spectrumoi.com](mailto:customer@spectrumoi.com)

## RETURN POLICY

As a condition to the obligation to repair or replace your product, the product needs to be returned to Spectrum Optical Instruments with proof of original purchase from Spectrum Optical Instruments or an authorized dealer.

A claim is required to be filed before return of a product. A claim template can be obtained from Spectrum Optical Instruments by email. Please contact customer service at [customer@spectrumoi.com](mailto:customer@spectrumoi.com) in such an event. Each return product must include a written statement detailing the nature of the claimed defect. As well as the original purchaser's name, address, and contact information.

Buyers are responsible for return shipping and handling cost for warranty services after 30 days of original purchase. Our warranty covers parts and labor only.

Spectrum Optics reserves the right to replace an obsolete product with a new product of comparable price and performance. In event of a defected product shall be replaced by a new product, the defected product become the property of Spectrum Optics. Spectrum Optics does not issue refunds but only repair or replacement.

## CUSTOMER SERVICE

### US-based team, Lightning-fast Response

When you reach out to us, you're not just getting assistance; you're connecting with a team of professional experts right here in California. We're proud to be based in the USA, and we stand by our commitment to provide you with answer and support within 24 hours. Your questions and concerns are our top priority.

Email us: [customer@spectrumoi.com](mailto:customer@spectrumoi.com)

Visit our website: [www.spectrumoi.com](http://www.spectrumoi.com)

